

SERIE/MODEL	EC-N □□□/Z
CODICE/CODE	07.50.□□□.01

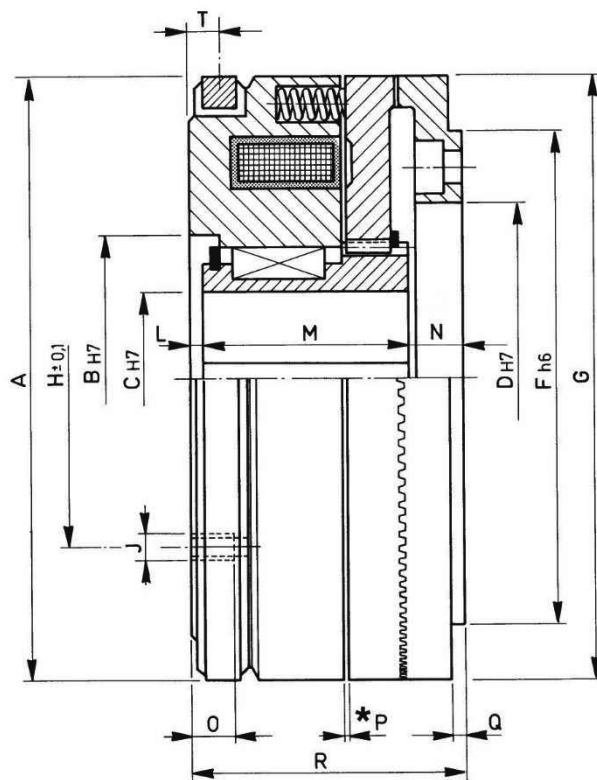
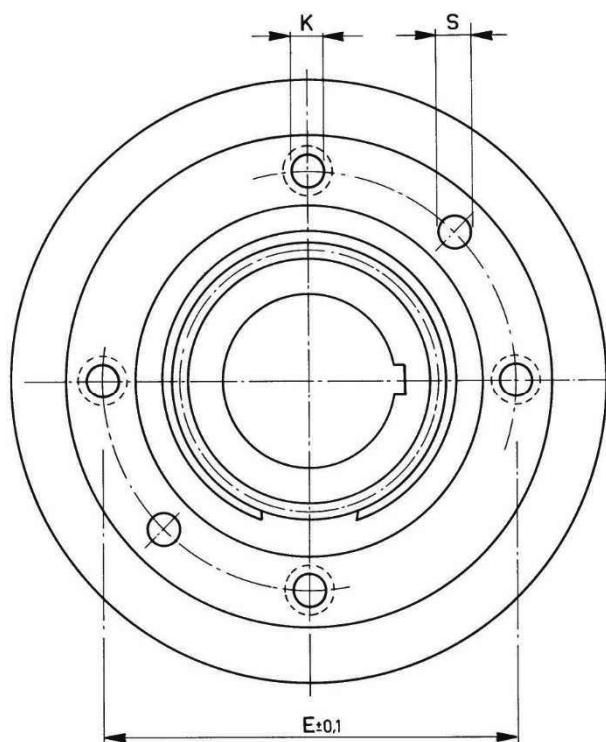

* P = Regolazione traferro / Air gap adjustment (pag. 51)

□□□	Momento Torque Ms max. (Nm)	Giri/1' R.P.M. limit max	Watt		Spinta assiale sulla corona dentata Axial thrust on the crown ring daN			Peso Weight kg
			20°	120°				
082	25	4500	30	22	22		1,8	
090	35	4000	38	27	30		2	
105	70	4000	38	27	51		2,7	
115	100	3500	50	36	67		3,5	
125	160	3300	65	47	100		4,4	
140	250	3000	85	61	140		6,3	
160	400	2500	96	69	190		9	
185	650	2200	115	83	270		14	
215	1050	2000	135	97	370		20	

□□□	A	B	C Max.	D	E	F	G	H	J N°xφ	K N°xφ	L	M	N	O Max.	P	Q	R	S N°xφ	T
082	82	40	18	46	56	65	82	54	4xM5	4x4,5	2	40	5	8	0,8	1,5	47	2x4	5
090	90	46	25	53	64	75	90	54	4xM4	4x5,5	2	31,5	6,5	10	0,8	2	40	2x5	5
105	105	52	28	65	75	85	105	62	4xM5	4x5,5	2	36	6	10	0,7	2	44	2x5	5
115	115	58	32	70	85	100	115	68	4xM6	4x6,5	2,5	38,5	9	12	1	2	50	2x6	6
125	125	62	35	75	90	105	125	72	4xM6	4x6,5	2,5	44,5	11	12	1,1	2,5	58	2x8	6
140	140	70	42	85	100	115	140	80	4xM6	4x6,5	2,5	54,5	10	13	1,1	2,5	67	3x8	7
160	166	78	45	95	115	130	160	90	4xM8	6x8,5	3	59	13	15	1,1	3	75	3x8	8
185	185	84	50	115	135	155	185	106	6xM8	6x8,5	3	68	14	15	1	3	85	3x10	8
215	210	96	60	130	155	180	215	124	6xM8	6x8,5	3	81	16	15	1,5	4	100	3x10	8